



Features:

1. 4.0 inch(101.6mm) Digit Height.
2. Continuous uniform segments.
3. Low power requirement.
4. Excellent characters appearance.
5. Solid state reliability.
6. Categorized for luminous intensity.
7. Duplex drive common anode or cathode.

Description:

1. The ULS-40101AX/BX is a 101.6mm(4.0") high Single digit 7-segment alphanumeric display.
2. The High Red(**S**) source color devices are made with Gallium Arsenide Phosphide on Gallium Phosphide Orange Light Emitting Diode.
The Yellow Green(**G**) source color devices are made with Gallium Phosphide Green light Emitting Diode.
The Yellow(**Y**) source color devices are made with Gallium Arsenide Phosphide on Gallium Phosphide Yellow Light Emitting Diode.
The Super Bright Red(**SR**) source color devices are made with Gallium Aluminum Arsenide Red Light Emitting Diode.
3. The product have a black/gray/red face and white/red/green/yellow segments.



漳州市晶艺佳电子制造有限公司

ZhangZhou Jingyijia Electronic Manufacture Co.,Ltd.

ULS-40101AX/BX

4.0" Single Digit Display

Package Dimensions:

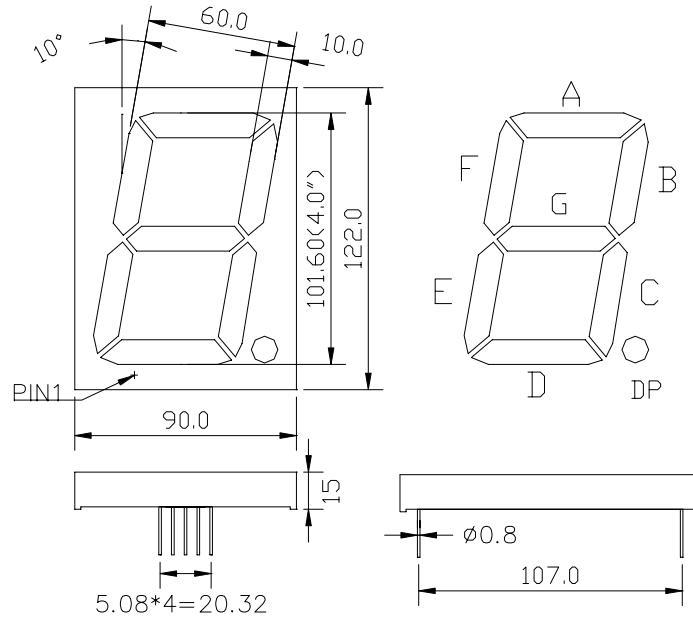

Internal Circuit Diagram:

40101AX

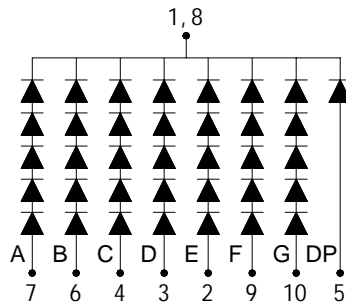

40101BX

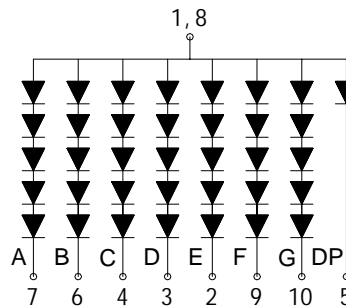



漳州市晶艺佳电子制造有限公司

ZhangZhou Jingyijia Electronic Manufacture Co.,Ltd.

ULS-40101AX/BX

4.0" Single Digit Display

Selection Guide

Part No.	Dice	Iv(mcd)		Description
		Min.	Typ.	
ULS-40101AS	HIGH RED(GaAsP/GaP)	10	12	Com Cathode
ULS-40101BS				Com Anode
ULS-40101AG	YELLOW GREEN (GaP)	13	16	Com Cathode
ULS-40101BG				Com Anode
ULS-40101AY	YELLOW(GaAsP/GaP)	11	14	Com Cathode
ULS-40101BY				Com Anode
ULS-40101ASR	SUPER BRIGHT RED (GaAlAs)	30	40	Com Cathode
ULS-40101BSR				Com Anode

Electrical/Optical Characteristics at Ta=25

Symbol	Parameter	Device	Typ.	Max.	Units	Test Conditions
peak	Peak Wavelength	High Red Yellow Green Yellow Super Bright Red	640 565 590 660		nm	IF=20mA
D	Dominate Wavelength	High Red Yellow Green Yellow Super Bright Red	638 568 588 640		nm	IF=20mA
1/2	Spectral Line Halfwidth	High Red Yellow Green Yellow Super Bright Red	45 30 35 20		nm	IF=20mA
C	Capacitance	High Red Yellow Green Yellow Super Bright Red	15 15 20 45		pF	VF=0V;f=1MHz
VF	Forward Voltage	High Red Yellow Green Yellow Super Bright Red	1.8 2.2 2.0 1.8	2.2 2.4 2.2 2.3	V	IF=20mA
IR	Reverse Current	All		10	uA	VR=5V

Absolute Maximum Ratings at Ta=25

Parameter	High Red	Yellow Green	Yellow	Super Bright Red	Units
Power Dissipation	105	105	105	100	mW
DC Forward Current	30	25	25	25	mA
Peak Forward Current[1]	150	150	150	150	mA
Reverse Voltage	5	5	5	5	V
Operating/Storage Temperature	-40 To +85				
Lead Solder Temperature[2]	260 For 5 Seconds				

Notes:

- 1/10 Duty Cycle, 0.1ms Pulse Width.
- 4mm below package base



TYPICAL ELECTRO-OPTICAL CHARACTERISTICS CURVE:

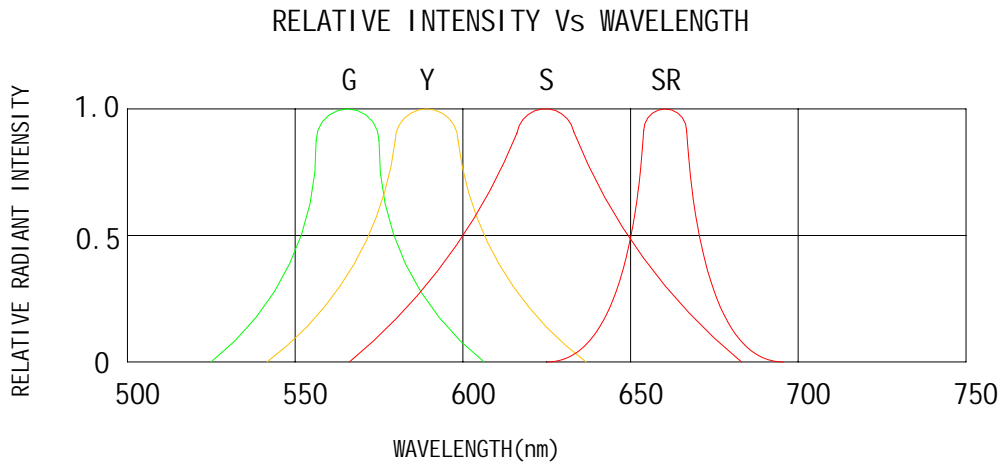

High Red

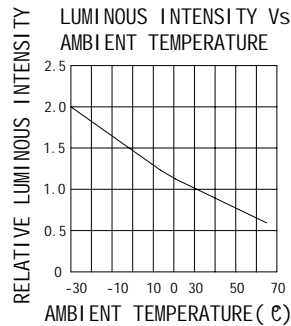
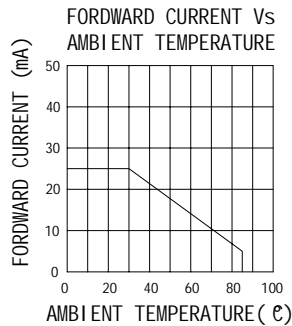
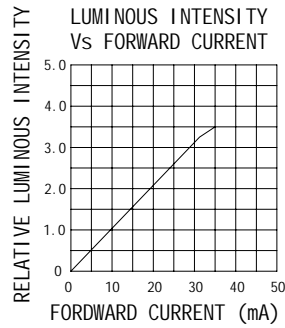
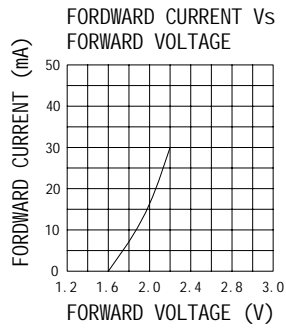



漳州市晶艺佳电子制造有限公司

ZhangZhou Jingyijia Electronic Manufacture Co.,Ltd.

ULS-40101AX/BX

4.0" Single Digit Display

Yellow Green

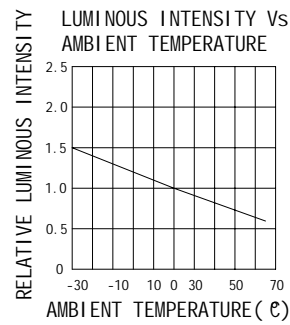
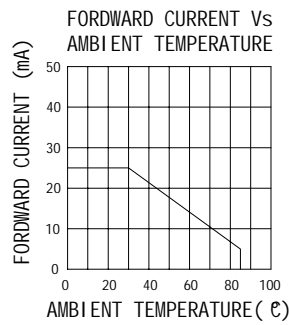
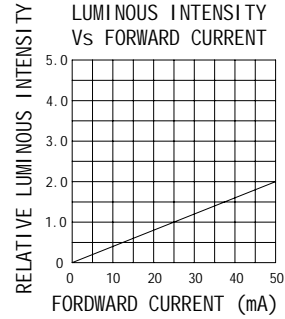
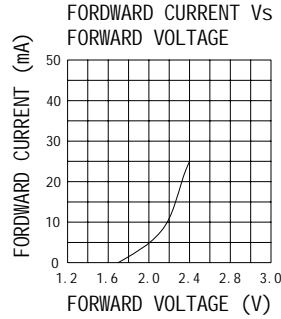

Yellow

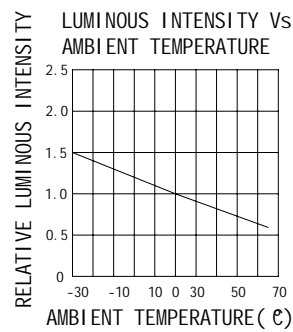
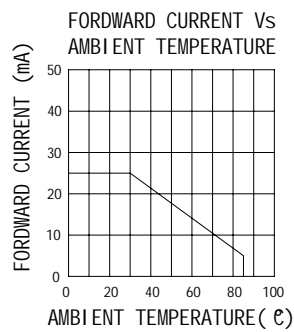
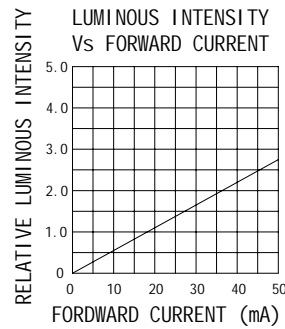
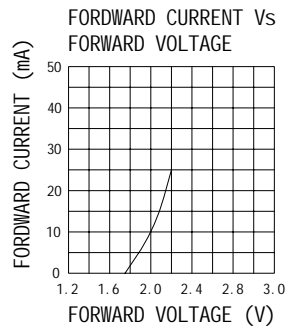



漳州市晶艺佳电子制造有限公司

ZhangZhou Jingyijia Electronic Manufacture Co.,Ltd.

ULS-40101AX/BX

4.0" Single Digit Display

Super Bright Red

